



Viron P320 eVo  
Viron P600 eVo  
Pool and Spa Pumps

**ASTRAL**POOL 

## INSTALLATION AND OPERATING INSTRUCTIONS



Viron P320 eVo



Viron P600 eVo



SERIOUS INJURY OR DEATH MAY OCCUR IF THIS PRODUCT IS NOT USED, OPERATED OR INSTALLED ACCORDING TO THESE INSTRUCTIONS AND RELEVANT AUSTRALIAN STANDARDS.

**WARNING**



THIS APPLIANCE IS NOT INTENDED FOR USE BY YOUNG CHILDREN OR INFIRM PERSONS. PLEASE ENSURE YOUNG CHILDREN ARE SUPERVISED SO THAT THEY DO NOT PLAY WITH THE APPLIANCE.

**WARNING**



PUMP PRODUCES HIGH PRESSURES – STAND CLEAR OF PUMP AND ALL FILTRATION EQUIPMENT DURING START UP

**WARNING**



PUMP MUST ONLY BE INSTALLED BY A QUALIFIED POOL INDUSTRY PROFESSIONAL. INSTALLERS, OPERATORS AND OWNERS MUST READ THESE INSTRUCTIONS BEFORE USE.

**WARNING**



PUMP AUTOMATICALLY RESTARTS AFTER HIGH LIMIT OPERATION, DISCONNECT POWER TO PUMP BEFORE MAINTENANCE OR REPAIR

**WARNING**



INCORRECT SETTING OF THE SPEEDS ON THIS PUMP MAY CAUSE ADVERSE FILTRATION OR OPERATION OF THE SWIMMING POOL OR SPA. ENSURE PUMP IS INSTALLED, SET AND COMMISSIONED BY AN AUTHORISED ASTRALPOOL DEALER.

## GENERAL

---

The Viron EVO Pool Pump is a unique variable-speed permanent magnet DC motor combined with an energy efficient pump wet end. When installed and plumbed correctly, the Viron EVO will significantly reduce operating costs, lower noise levels and reduce greenhouse emissions.

The Viron EVO Pool Pump range is available in a variety of models, with the following factory set speeds which offer approximate flow rates:

Model	High	Medium	Low
Viron P320 EVO	320 lpm	206 lpm	128 lpm
Viron P600 EVO	600 lpm	426 lpm	200 lpm

(Flow rates based on a maximum speed at 8 m total dynamic head).

Each speed can be easily changed to suit your pool size, filter, plumbing and application. The Viron eVo Series pumps must be installed by a pool professional trained by AstralPool to ensure it has been selected for the correct application, is correctly installed and set up to suit your pool and its operation fully explained to you.

## FEATURES

---

- Continuous duty rated motor
- Precision reinforced moulded high head impeller, giving extra performance
- Single piece moulded body for added strength and longer life
- Rapid priming diffuser quickly corrects loss of water flow
- Quick and easy disassembly for servicing
- Large capacity basket with easily removed ramp on lid
- Ability to adjust factory preset speeds for optimum water flow and maximum energy savings for your pool and its equipment
- Double Insulated water circuit for maximum electrical protection

## DIMENSIONS

---

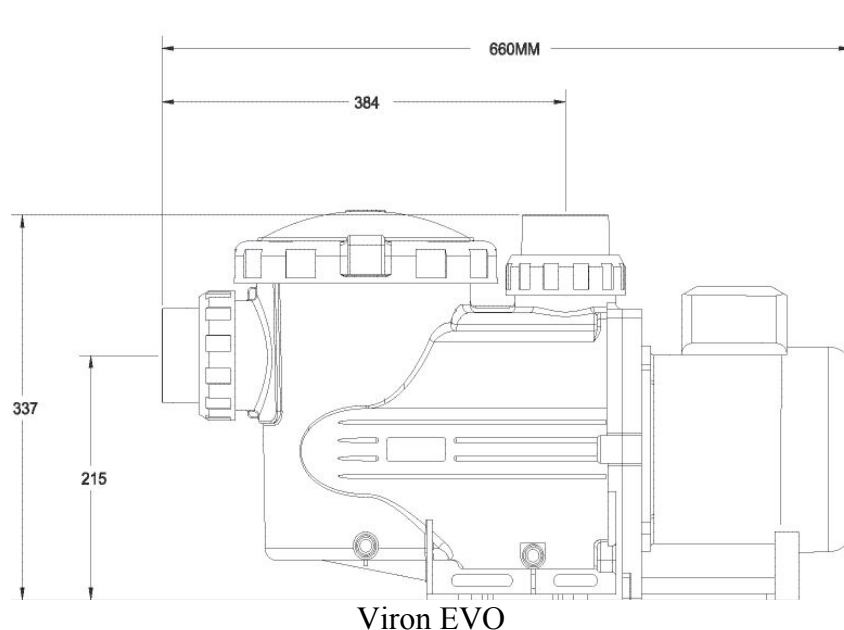

## INSTALLATION

---

This appliance must be installed by a trained pool professional service technician. When installing the appliance, ensure all parts are installed in the correct zone in accordance with the wiring rules. In particular refer to AS/NZS 3000 (Australia) and EN 60364 (EU).

**A.** Plan position of pump so that it will be:

1. Free of water flooding, such as in a sump, garden hollow, ditch or at bottom of bank with run off.
  2. On a stable base so that:
    - a) The pump is not left suspended by its fittings, causing a leak or failure with loss of water
    - b) Movement through vibration is restricted
    - c) No strain is put on attaching pipe or other expensive equipment
  3. Accessible for maintenance and easily removed for service.
  4. Breathing space. Pump should not be crowded which will prevent cooling airflow from fan. Overheating due to lack of cooling voids warranty.
  5. Within reach of power point without extension/plugs liable to corrosion, shorting, etc.
  6. At a minimum height of suction lift of water from pool surface to pump inlet.
- B.** For best pump performance keep suction pipe length as short as possible with minimum number of bends and use 50mm high pressure PVC suction and return pipe. All equipment such as filters, heaters, chlorinators must have a minimum of 50mm connections.
- C.** Secure the barrel unions supplied into the attaching pipe work, using approved priming fluid and solvent cement as normal practice, coating both surfaces. **NOTE:** Always wear protective gloves when handling and using glue and priming fluid. Ensure no excess adhesive runs into the union proper affecting the sealing or removal abilities. Allow 24 hours to dry before starting pump. Do not use "green" glue on barrel unions. This can cause damage to the ABS material used to manufacture the unions.
- D.** Install isolation valves before the pump section and after equipment, if the pump is below the water level of the pool.
- E.** For pump installations 500mm above water level, it generally requires a foot valve at the pool or check valve in the suction line. Suction lines must be installed below water level until just in front of pump location and vertical riser used to reach pump inlet. AstralPool pumps are rated to a maximum head of 25 metres however refer to your pump's data plate for actual achievable pressure.
- F.** All pumps will operate quieter and perform more efficiently if a straight length of 450mm pipe is plumbed horizontally into the front of the pump.
- G.** Water temperature not to exceed 45 degrees Celsius.
- H.** Pumps must be either
- supplied by an isolating transformer, or
  - supplied through a residual current device (RCD) with a rated residual operating current not exceeding 30mA.

**Warning:** Viron pumps include PCB's and microchips. It is necessary to turn power off completely for 10 seconds before turning pump back on again. Some brands of chlorinators may bleed a small amount of power into the Viron Pump even when the pump off mode is selected. If this occurs, the Viron Pump may not reset correctly and may not start until power is disconnected completely. In some cases, the manufacturer of these chlorinators may be able to remove or change a capacitor which will completely disconnect power to the pump when turned off. If not, a suitable chlorinator may be required to be purchased. Astral Pool chlorinators completely disconnect power to the pump when the pump off mode is selected.

## OPERATION

---

1. Prime pump if hair and lint pot is dry as follows – Close off valve on suction line if present. Remove lint pot lid. Fill lint pot and chamber with water. Replace and secure lint pot lid and seal.
2. Open all valves, allowing water to flow through pump.
3. Switch on power to pump.
4. If some flow of water does not establish within one half minute, switch off and prime pump again. If pump does not prime within 3 attempts, check all suction connections for sealing. If these are satisfactory, a check or foot valve is required to hold water for prime.
5. If the water flow through pump is always tedious to obtain at start-up after cleaning the lint basket, then an examination of the system to establish a reason and correct the cause is recommended. Eg. Check valve, air leaks, faulty seal, cracked lint pot lid, etc.
6. The Viron EVO has 3 factory preset speed settings – Low, Medium and High. High should be used when backwashing, manually vacuuming the pool or operating spa jets or some water features such as waterfalls. Medium speed can be used for gentle spa jet action, when suction cleaner is connected to the skimmer or filtration for the pool. Low is the recommended setting for everyday filtration of your pool when a cleaner is not connected.
7. The Viron EVO will automatically start on High for the first 5 minutes to assist in priming and substantially fill the hair and lint pot with water. After 5 minutes the pump will revert to the last speed it was set at before it was turned off.
8. During normal operation, it is recommended that the pump be operated on Low for 12 hours per day. This will achieve the lowest operating costs with the lowest noise level. Should your pool have areas where water is not turning over when pump is on Low, increase the speed setting.

**Notes:** The appliance is not intended for use by person including young children or infirm persons with reduced physical, sensory or mental capabilities, or lack of experience or knowledge, unless they have been given supervision or instruction concerning use of the appliance by a person responsible for their safety.

Please ensure that young children are supervised to ensure that they do not play with the pump.

To avoid a safety hazard, the supply cord if damaged, must only be replaced by AstralPool, or its service agent or a suitably qualified person.

### Hours of Operation

On low speed your Viron pump makes very little noise and is unlikely to be intrusive to you or your neighbours. Generally, your pool filter pump should operate for a minimum of 8 hours a day to provide sufficient skimming (thereby reducing the amount of debris that falls to the bottom of the pool) and to allow the chlorinator to provide sufficient chlorine to sanitise your pool.

**Greater energy savings occur when operating the pump for longer periods at the lowest speed instead of operating for shorter periods at a higher speed.**

## SELECTION OF APPROPRIATE SPEEDS

### General Rules:

- The total volume of water in your pool should be turned over at least once a day.
- If operating for longer periods of time, you may be able to turn the output of your salt chlorinator to a lower level. Check your chlorine level frequently to ensure you do not over or under chlorinate your swimming pool.
- **Low Speed** is factory pre set and is the recommended setting for your daily filtration flow rate – enough to gently turn the water over once per day and circulate the water completely around your pool.
- **Medium Speed** is generally set up as your special purpose flow rate. For example, an infloor cleaning system will require higher pressures and flow rates to operate and medium speed can be set up to operate the infloor cleaning system. Other special purpose flow rates may include but are not limited to: operating spa jets, operating water falls or water features, operating a suction pool cleaner.
- **High Speed** is generally set up to backwash your sand filter. As a rule of thumb, this speed should be set so that the gauge on your filter is approximately 70kPa to 100 kPa in pressure but this will depend on the size of your filter, and the size and length of the backwash pipe line.

In warmer weather, or when the pool is used a lot, your pump should operate for 12 hours a day or more. Check your chlorine levels and visually inspect your water to ensure that (a) you have adequate chlorine and (b) the water in your pool looks clear and inviting. If you have any doubts, take a sample of water to your local pool shop for a water analysis.

Examples of Speed Selection during operation and use of your Viron P280 or P300 eVo Pump:

<i>Function</i>	<i>Speed</i>
Vacuuming Pool or Spa	High Speed
Operating Spa Jets	High Speed
Operating Waterfall or Water Feature	Medium Speed or High Speed, depending on effect required
Cleaning up pool with Cloudy Water	Up to 24 hours on High Speed
General Filtration	Low Speed (8 hours in winter, 8 to 12 hours in summer)

### Some Tips:

The P320 will provide around 15,000 to 18,000 litres per hour on high speed, depending on pipework, valves, filter size and other equipment installed on your pool. On low speed the factory preset flow rate is approximately 7,500 litres per hour. **Low speed will use approximately 10% of the power consumption** that high speed will use. Therefore, operating the pump 8 hours per day will provide a 60,000 litre pool one complete turn over.

The P600 pump will provide around 36,000 litres per hour on high speed, depending on pipework and the Factory preset low speed at 1125 RPM will provide around 12,000 litres per minute. This is sufficient to turn a 96,000 litre pool over once per day.

As a guide, low speed should achieve a visible skimming of the surface of the pool through your skimmer box. When connected to an AstralPool compatible salt chlorinator, Viron Connect Touch Screen Control System, we recommend that for one hour a day the filtration period is operated on at least medium speed to achieve full circulation and good surface skimming of the pool. The balance of the filtration cycle can then be set on low speed.

However, should your pool water develop cloudiness or your pool surface exhibit algae growth you may need to increase the low speed of your pump to ensure adequate circulation of water and chlorine to all parts of your pool.

It is important to check your chlorine levels, pH and other parameters to ensure your water quality is correct before adjusting the speed of your pump. We recommend these checks are carried out by your professional pool shop or service technician.

## OPERATION OF CONTROL PANEL – VIRON P320 EVO & P600 EVO

---

The Viron P320 and P600 eVo pumps incorporate an LCD backlit screen with the following features:

In built time clock:

- Programmable for up to four timer periods each day
- Timer periods can be disused and 1, 2, 3, or 4 periods selected
- Different speed (low, medium, high) for each timer period
- Displays actual RPM of motor and low, medium and high speed can be adjusted to suit your pool
- Time clock and timer periods can be disabled if connected to an external time clock
- Can be programmed by a compatible AstralPool remote control or chlorinator to operate at different speeds during different times of the day
- Enables the priming (start up) speed to be adjustable and the time of the start up speed to be changed from 2 minutes up to 120 minutes

Viron eVo Control Panel

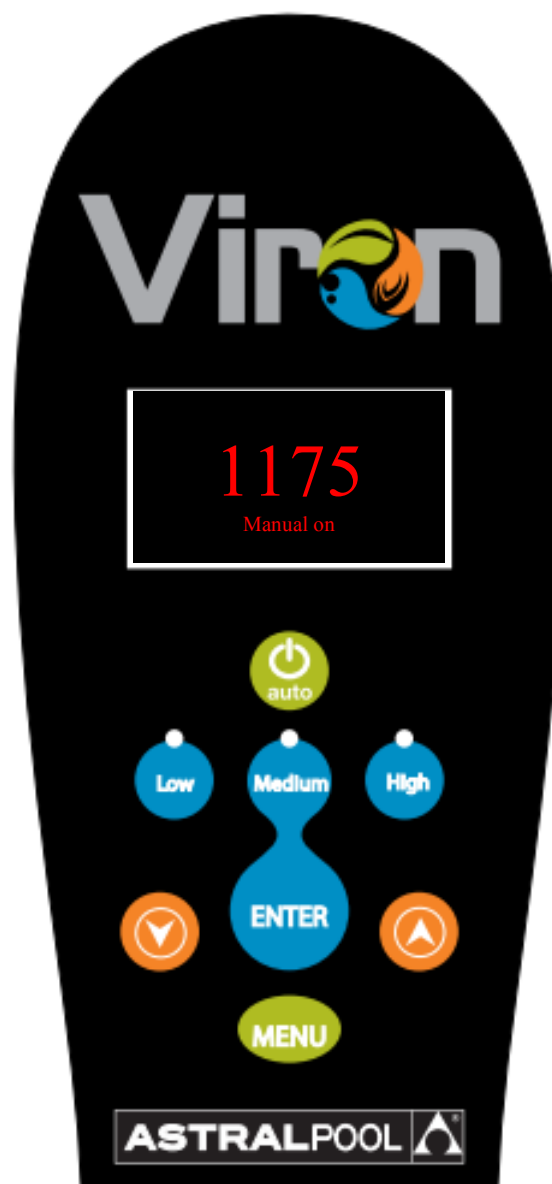

## OPERATION OF CONTROL PANEL – VIRON P320 & P600 EVO (CONT...)



---

Using the inbuilt timer to operate pump with an AstralPool Chlorinator or RolaChem dosing unit.

### Factory Default Setting

1. The inbuilt timers are activated and will control the time the pump operates.
2. Connectivity to AstralPool compliant Salt Chlorinators, RolaChem Chemical dosing controllers or Viron Connect remote Controls is turned “off”.
3. Use the  “auto” button to turn the pump on or off. When in on position, the pump will remain off until the next timer period unless pressed again to manually on. If pump is turned to manually on, it will continue to operate indefinitely. If in the “Off” position (visible on the LCD), the pump will remain indefinitely off. For timer operation, ensure the “auto” button is pressed so that the LCD screen displays “auto”.

### Setting the current Time

1. If connected to a compliant AstralPool Salt Chlorinator or RolaChem dosing controller connect data cable between rear of pump and the chlorinator or RolaChem dosing unit.
2. Connect and turn power on to the pump and Chlorinator (or dosing unit).
3. Toggle “menu” (twice) until “CLK” appears and press “enter” to set time. Use  up and down  arrows to set the hour, press “enter” again to set minutes and then press “enter” again to set AM or PM.
4. Press  “enter” to accept.
5. The LCD screen will quickly flash 3 times to indicate the new setting has been accepted.

### Setting pump to operate independently of external AstralPool Compliant Chlorinator or Control System

1. Toggle Menu until “CONF” is displayed on the LCD screen.
2. Press and HOLD “enter” for 3 seconds. “TMRS” will appear.
3. Press “enter”.
4. Press UP or Down buttons to turn “TMRS ON”.
5. Press “enter” to accept.
6. Press  “auto” to return to main menu.

### Changing Low, Med and High Speed Settings

1. Select the Speed Button to be adjusted, Low, Medium or High. Respective LED will light up.
2. Alter the speed in increments of 25 RPM using the up and down arrows until the desired speed is displayed on the screen. Respective “Speed 1”, Speed 2” or “Speed 3”, will flash while editing.
3. The new speed will automatically save after 2 seconds. Flashing will stop to signal save.

### Setting filtration timer periods

1. Press Menu to go to PRIM setting.
2. Prime period is defaulted to 5 minutes and high speed. We recommend if your pump is installed at or below water level, you change the PRIM to 2 minutes. Press “enter” and then Up or Down arrows to change the prime speed. Press “enter” to accept. Priming period will now be displayed.
3. Use the Up or Down arrow to change the Priming period. Press “enter” to accept.
4. Press Menu to go to TMR “timer settings” and press “enter” to change.
5. Timer 1 is factory set to start at 8 am. Use up or down arrows to change. Press High, Medium, or Low to select the speed of the pump during Timer 1. On the LCD Screen High is represented by speed “1”, medium by speed “2”, and Low by speed “3”.
6. Press Enter to move to the stop or end time of Timer 1. Use the up and down arrows to change the end of Timer 1.
7. Timer 2 will now appear on the LCD Screen. Repeat instructions 4. to 6. Above.
8. Timer 3 will now appear but is factory preset to OFF. Moving any timer to midnight will turn that Timer period off. Use the up and down arrows to activate the time and repeat process 4 and 5 above.
9. Timer 4 is also factory preset to “off” but can be activated by using the up and down arrows.
10. Remember to select the speed you wish to operate during each timer period by pressing the High, Medium or Low buttons while still in the Timer Start program.



### Using the in built pump timers with a non compliant chlorinator or dosing unit.

1. We do not recommend the use of the pump timers when a non compliant chlorinator or chemical doser is supplied water flow by the Viron P320 or P600 eVo pump.
2. In this case, the pump operating hours should be controlled by the chlorinator time clock and the pump plugged into the chlorinator. This is a safety measure provided for by most chlorinator manufacturers.
3. However, it is important to deactivate the inbuilt pump timers.
4. Toggle Menu until "CONF" is displayed on the LCD screen
5. Press and HOLD "enter" for 3 seconds
6. Toggle Menu until "TMR" appears
7. Press UP or Down buttons to turn "TMR OFF"
8. Press "enter" to accept
9. Press  "auto" to return to main menu.
10. When cycling through the Menu button TMR will no longer appear.
11. You will no longer be able to automatically have the speed of the pump changed during different times of the day.
12. However, if you wish for a period where the pump operates at a high speed, for example to circulate the water vigorously for a part of the daily filtration, you can use the PRIMING setting to do so.



### Using the PRIMING program to circulate the water at a higher flow rate for part of the daily filtration cycle.

1. Toggle Menu to go to PRIM setting.
2. Prime period is defaulted to 5 minutes and high speed. Use the up and down arrows to change the Priming period up to 120 minutes. Use the High, medium, or low buttons to select the speed you wish the pump to operate for during the Priming period. In this case, we recommend the High Speed button be selected.
3. Press "Auto" to exit the programming.

### Using Pump with AstralPool compliant external control

AstralPool manufactures Salt Chlorinators, RolaChem chemical dosing units or the Viron Connect Touch Screen Control system which can control both the operating times of the all Viron eVo pumps PLUS the speed the pump operates at during each timer period.

For the P320 & P600 you must enable the communication port and disable the Pump in built timers.

1. Toggle Menu until CONF (configure) appears. Hold enter for 3 seconds.
2. Toggle Menu until "TMR" appears.
3. Press UP or Down buttons to turn "TMR OFF". Remember, you are now using the external control to set the pump operating hours, so the pump timer must be turned off.
4. Press "enter" to accept
5. Toggle menu until SYS (system) appears. Press the  up or down  button and turn to "ON". The Viron P320 or P600 eVo will accept the start, end and pump speed instructions from the AstralPool compliant control chlorinator, Rolachem dosing controller or Viron Connect Touch Screen Control.
6. Press  "auto" to return to main menu.
7. The time will still be visible on the LCD display however, the timer function in the menu setting will no longer appear. Toggle the menu button will now only display PRIM (priming program), CLK (clock setting) and CONF (Configuration menu).
8. Refer to your AstralPool compliant Chlorinator, RolaChem Dosing Control or Viron Connect Touch Screen Control manual for details of programming the pump speed and operating hours.

### Fault Codes

#### The P320 & P600 Pump only

Fault Code (displayed on screen)	Meaning
HI T	Over Temperature
HI A	Over Current
Lo V*	Under Input Voltage
BSUC	Motor is Stuck

\*Please note: It is normal for the "Lo V" fault code to display briefly on start up.

**Data cable connector:**

If a compatible AstralPool VX Salt Chlorinator, Viron Salt Chlorinator or Viron Connect Touch Screen, is connected with the AstralPool communication cable, the speed of the pump and operating hours can be controlled by these devices.

The Viron P320 & P600 eVo must have its inbuilt timer deactivated if the pump operating times and speeds are to be operated by the compatible AstralPool Salt Chlorinator, RolaChem Dosing Controller or Viron Connect remote touch screen.

Remove 2 philips head screws from rear of pump and the data port cover is removed by hand. Plug RJ12 6 wire flat cable purchased from AstralPool into rear of pump and reassemble. To achieve a proper seal, press the flat cable under the guide tabs (detailed view A). Slide data port cover back on by aligning the tabs with the slots and the flat cable with the recess (detailed view B).

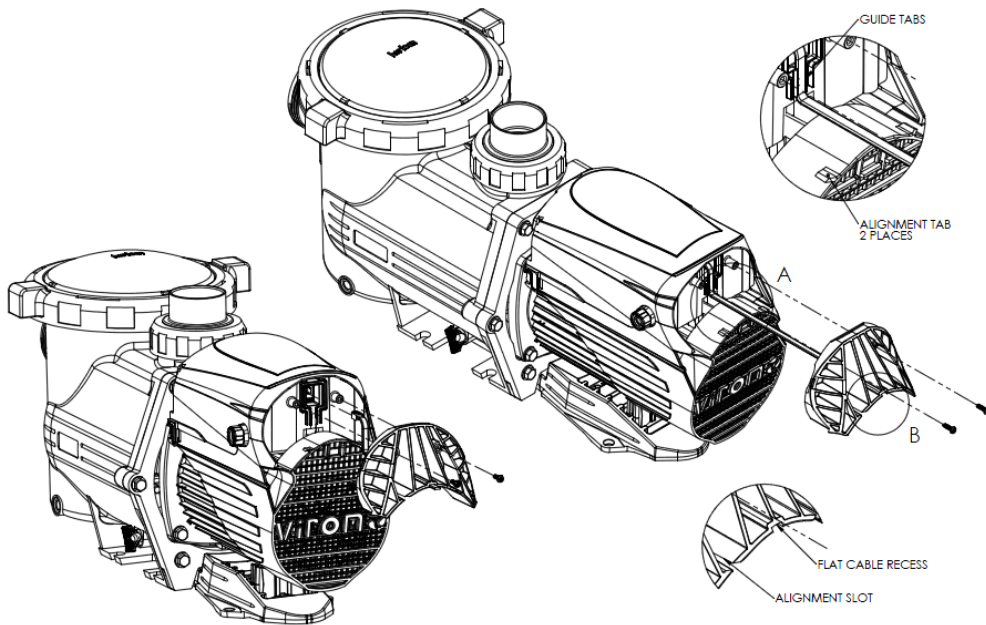

## REMOTE CONTROL OF SPEEDS AND TIMER FUNCTIONS

- Viron eVo pump stand alone
  - 4 built in timer periods in pump
  - 3 programmable speed settings
  - Low, medium or high speed can be selected in each timer period
  - Priming period can be selected from 2 to 120 minutes
  - Prime RPM can be selected from 1275 to 2850 RPM



240v power —  
24v comms data —

Inst.300 Viron EVO Pool & Spa Pump V01.



- All model Viron eVo pumps and compatible VX Timer model chlorinator or Viron Salt Chlorinator
  - Timer periods set up in chlorinator
  - Low, medium or high speed can be selected for each timer period
  - Data cable connecting pump to chlorinator via comms interface module
  - eVoPump to be set up with timer periods deactivated
  - Pump speed can be changed from pump (from chlorinator early 2012)



- All model Viron eVo pumps, VX S (non timer) model chlorinator and Viron Connect Remote Control System
  - Timer periods set up in controller
  - 3 programmable speed settings on pump
  - Select low, medium or high speed during each timer period
  - Data cables connecting pump/chlorinator/controller
  - eVo Pump to be set up with timer periods deactivated
  - Pump speed can be changed from pump or controller

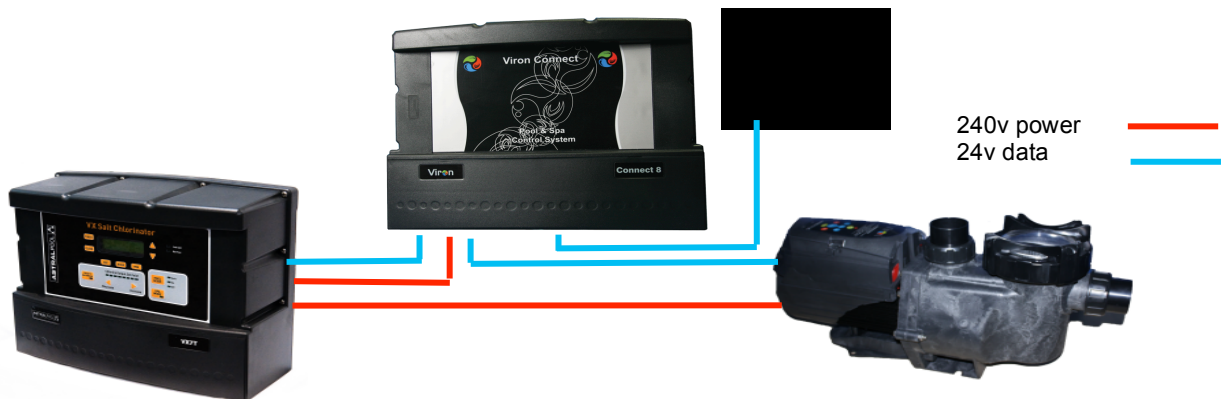

## SPEED SELECTION EXAMPLES FOR VIRON P600 EVO

---

<i>Function</i>	<i>Speed</i>
Vacuuming Pool or Spa	Medium Speed (high speed may collapse vacuum hose)
Operating Spa Jets	Medium or High Speed
Operating Waterfall or Water Feature	Medium Speed or High Speed, depending on effect required
Cleaning up pool with Cloudy Water	Up to 24 hours on High Speed
General Filtration	Low Speed (8 hours in winter, 8 to 12 hours in summer)
Single Pump Infloor Cleaning System	Medium Speed for 3 to 3 hours per day and low speed for 5 or 6 hours per day
Compatible Pressure Cleaner	2 or 3 hours per day on high speed, 5 or 6 hours per day on low speed

---

## USE WITH SUCTION CLEANERS

---

When connecting a suction cleaner to the Viron EVO pump, it is essential that full prime is achieved on the pump prior to connecting the cleaner hose. During operation at low speeds, the pump may only operate with partial prime in the hair and lint pot chamber.

To operate a suction cleaner on your pump;

1. Choose the speed button (low, medium or high) on which the pump will operate when the suction cleaner is connected.
2. Allow pump to operate for a minimum of 2 minutes to allow a full prime to be achieved.
3. Connect cleaner plate and hose to skimmer/wall suction only after all air has been purged from the top of the hair and lint pot of your Viron Pump.
4. Adjust speed (with increase or decrease buttons) at which the cleaner will travel to all areas of the pool. Factory set medium speed will usually operate all suction cleaner types in most pools. If using the Low Speed setting, it will usually be necessary to increase the low speed to ensure the suction cleaner operates reliably.
5. When cleaner is no longer required, disconnect and remove hose/cleaner plate from system. Select the lowest filtration speed that keeps your pool clean.
6. If replacing or selecting a new cleaner, AstralPool recommend a AstralPool Robot Cleaner which operates independently from the filter pump and allows the pump to operate at a speed which offers the maximum energy (and cost) savings.

## USE WITH ASTRALPOOL GAS HEATERS

---

Gas heaters (and electric heat pumps) generally rely on a water pressure switch to activate the heater control circuit. When a variable speed pump operates on low speed the water pressure produced is generally insufficient to activate the pressure switch and control circuit within the heater.

If using a compatible AstralPool Gas Heater you can automatically increase the speed of your Viron eVo pump to ensure the water pressure switch is activated and the heater obtains enough water flow to operate correctly.

A RJ12 (6 wire flat cable) specifically wired and obtained from AstralPool will connect your pump and heater. Refer to Heater Instruction Manual for data cable connection details.



Viron Pump when connected to Viron Heater or other compatible AstralPool Heater via RJ 12 cable	
Viron Heater Status	Viron Pump response
When heater is "off"	Runs at default speed set
When "on" but not lit	Runs at a minimum of medium speed. The user can use the buttons to select medium or high only (low speed button has no effect). The "start-up period" is cancelled.
When flame first lights	Runs at high speed. The user cannot change the pump's speed.
When flame is lost	Runs at default speed set or medium speed if heater power on

Viron Pump when connected to Viron Heater or other compatible AstraPool Heater via Viron Connect	
Viron Heater Status	Viron Pump response
When heater is "off"	Runs at the user's manual speed or the chosen default speed when operating due to timers.
When "on" but not lit	Changes to the higher of the speed which is configured by the user in the Installation Setup (the "Heater On" speed); or, the speed of the current timer. The user cannot change to low speed.
When flame first lights	Runs at high speed. The user cannot change the pump's speed.
When flame is lost	Runs at the user's manual speed or the chosen default speed when operating due to timers.

## MAINTENANCE

**Maintenance Schedule:** Your new product incorporates moving parts and withstands high velocity water with chemicals in it. Some of these parts will wear in the normal course of use and require regular checks and maintenance. Performing these checks and maintenance will identify parts that have worn and require repair/replacement before further serious damage is sustained. A small amount of regular care and attention to your pool equipment will help ensure long life and trouble free performance.

Timing	Maintenance Check	Service action (if required)
Weekly or sooner	Check and empty hair and lint basket	Empty leaves and debris
Three Monthly	Check Lid O ring and inlet/outlet O rings for leaks	Isolate Pump, turn power off, clean and grease O rings or replace if necessary
Three Monthly	Check surroundings for leaves, debris and	Remove debris and rectify if any flooding

	flooding	
Three Monthly	Check for leaks from underneath pump	Call Service technician, repair or replace mechanical seal and motor bearings if necessary

**Important note:** Regular maintenance is important to ensure long life and trouble free performance of your pool equipment. If unable to perform the maintenance yourself, contact your local Astral Pool office who will arrange a trained service technician to perform the maintenance for you.

# VIRON EVO CONTROL FLOW DIAGRAM

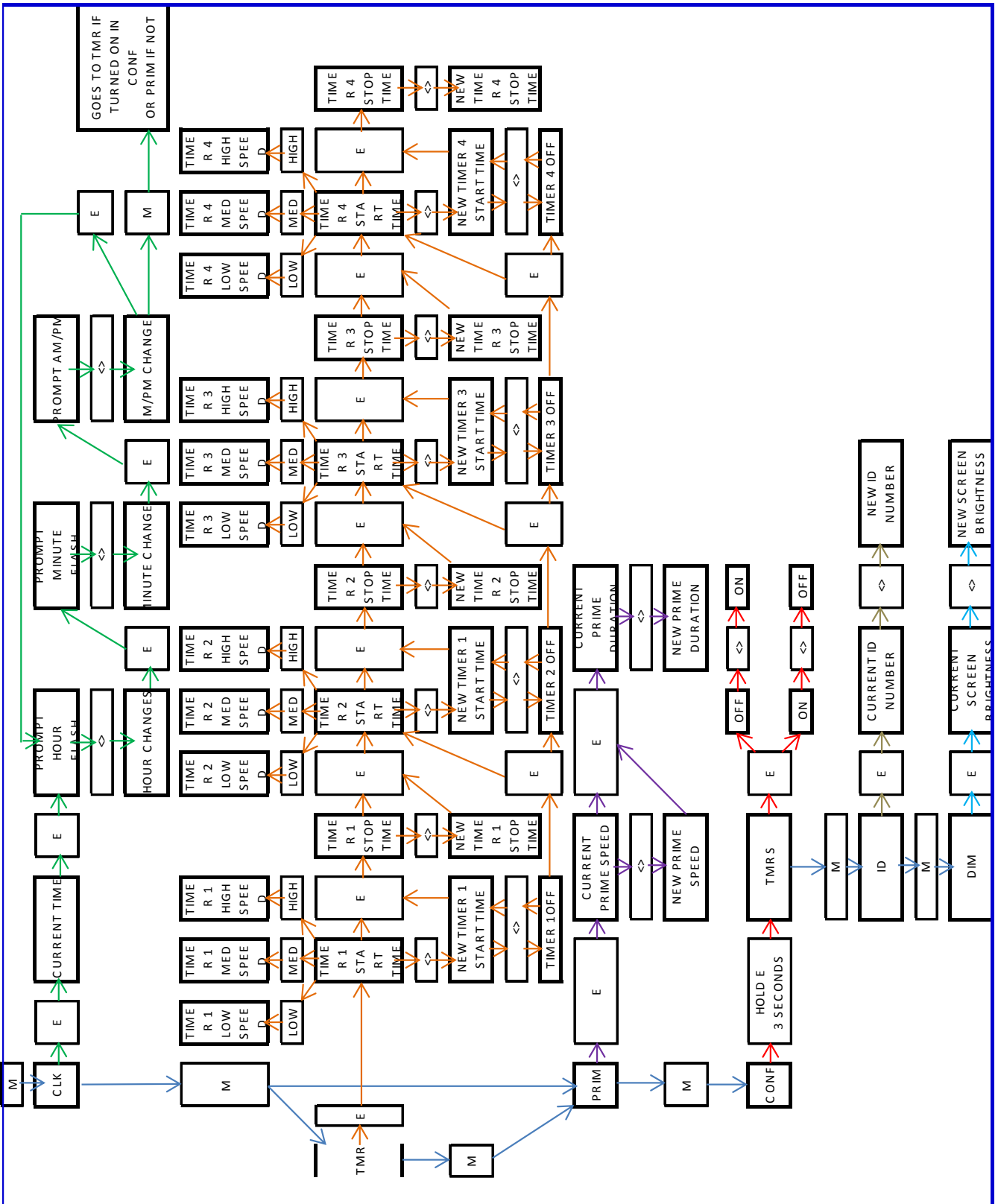

## WARRANTY

---

AstralPool Australia Pty Ltd (ABN 97 007 284 504) ("AstralPool") provides the following warranty in relation to its Viron eVo series Pool and Spa pumps ("Product").

*Our goods come with guarantees that cannot be excluded under the Australian Consumer Law. You are entitled to a replacement or refund for a major failure and for compensation for any other reasonably foreseeable loss or damage. You are also entitled to have the goods repaired or replaced if the goods fail to be of acceptable quality and the failure does not amount to a major failure.*

The benefits of this warranty are in addition to any rights and remedies imposed by Australian State and Federal legislation that cannot be excluded. Nothing in this warranty is to be interpreted as excluding, restricting or modifying any State or Federal legislation applicable to the supply of goods and services which cannot be excluded, restricted or modified.

### WARRANTY

AstralPool warrants that, subject to the exclusions and limitations below, the Product will be free from defects in materials and workmanship during the warranty period. The warranty periods are set out below and commence 30 days after the date of purchase (to allow for installation). The warranty period may vary for different parts of the Product.

Parts	Warranty Period
Complete assembly	3 years

If a defect appears in the Product before the end of the warranty period and AstralPool finds the Product to be defective in materials or workmanship, AstralPool will, in its sole discretion, either:

- (a) replace or repair the Product or the defective part of the Product free of charge; or
- (b) Cause the Product or the defective part of the Product to be replaced or repaired by an Authorised AstralPool Service Agent free of charge.

AstralPool reserves the right to replace defective parts of the Product with parts and components of similar quality, grade and composition where an identical part or component is not available.

Goods presented for repair may be replaced by refurbished goods of the same type rather than being repaired. Refurbished parts may be used to repair the goods.

### WARRANTY CLAIMS

1. If a fault covered by warranty occurs, the customer must first contact AstralPool at the contact address listed below, or an Authorised AstralPool Service Agent.
2. Any warranty claim must be accompanied by:
  - (a) proof of purchase;
  - (b) full details of the alleged defect; and
  - (c) appropriate documentation (such as historical and maintenance records).
3. The customer must make the Product available to AstralPool or its Authorised AstralPool Service Agent for inspection and testing. AstralPool or its Authorised AstralPool Service Agent will attend the premises where the Product is installed for inspection and testing. If the Product is installed:
  - (a) outside a capital city metropolitan area; and
  - (b) is not within a 20 km radius of an Authorised AstralPool Service Agent;then the customer may have to pay a travel fee.
4. If such inspection and testing finds no defect in the Product, the customer must pay AstralPool's usual costs of service work and testing. If such inspection and testing finds a defect that is not covered by this warranty, the customer must pay AstralPool's usual costs of service work plus any parts and labour required to repair the Product, unless recoverable from AstralPool on the failure of any statutory guarantee under the ACL.



## **Exclusions**

The warranty will not apply where:

- (a) the customer is in breach of the Terms and Conditions of Sale;
- (b) the Product was used for a purpose other than one it was intended for;
- (c) the Product was repaired, modified or altered by any person other than AstralPool;
- (d) the Product has not been installed, maintained and/or operated in complete compliance with the installation and operating instructions and any instructions by AstralPool;
- (e) the Product has been subject to accident, negligence, alteration, abuse or misuse.

The warranty does not extend to:

- a) normal wear and tear;
- b) weather and other environmental conditions including but not limited to storm, flood, and/or heat wave damage; or
- c) service and maintenance items.

Examples of exclusions include but are not limited to:

- running pump without sufficient water flow
- addition of chemicals directly to skimmer box

## **Commercial Installations**

On commercial installations, such as health clubs, motels/hotels and hydrotherapy facilities, the warranty is limited to parts and in field labour (within capital city metropolitan areas or 20 km radius of Authorised AstralPool Service Agents) for a period of 12 months from the date of purchase plus 30 days to allow for installation.

## **LIMITATIONS**

AstralPool makes no express warranties or representations other than set out in this warranty.

The repair or replacement of the Product or part of the Product is the absolute limit of AstralPool's liability under this express warranty.

This warranty is subject to the conditions and limitations listed herein. All warranties apply to the original purchaser of the product and are not transferable to new owners. You must notify Astral Pool upon the failure of any component within the warranty period to make a valid claim.

The warranty offered is only valid when the equipment has been used in a normal manner, for the purpose for which it was intended and in accordance with the operating and instruction manual. The replacement of maintenance items used in routine general maintenance are not covered by this warranty. Maintenance items may include (but not limited to);

- Union and lid gaskets / o'rings
- Mechanical seal
- Pre filter basket

This warranty does not cover any equipment that has been improperly installed, misused, neglected, damaged whether intentionally or accidentally, or repaired/replaced without authorization from Astral Pool or altered in any way from its original form. Specific items that will void warranty are (but not limited to);

- Use in non swimming pool applications
- Incorrect power supply and/or connection
- Addition of salt, chlorine and/or other pool chemicals through the skimmer

Extreme operating conditions beyond the control of Astral Pool such as improper power supply, extreme temperatures or other conditions that adversely affect the performance or life of the equipment will void the warranty. Insect infestation or penetration by sand, dust or other foreign bodies will void warranty.

Where in field labor warranty is provided, a 20km radius from an authorized Astral Pool agent is applied. If the location of the equipment is outside this area, travel charges will apply. If your request for a service call is deemed to be non warranty, you will be charged for a diagnostic service call.

Astral Pool reserves the right to repair or replace defective components or products at its sole discretion.

Astral Pool shall have no liability for incidental or consequential damages or delays caused either directly or indirectly by any malfunction of or defect of or failure of the equipment.

Where the equipment is installed in commercial situations including (but not limited to) hotels, motels, caravan parks, health clubs, public pools, body corporate installations, etc the warranty is limited to 12 months.

Proof of Purchase must be retained for all warranty claims. Warranty will not be considered without Proof of Purchase. No person is authorized to make any representation or warranty on behalf of Astral Pool without express written consent from Astral Pool.

Record your Equipment details here for quick reference:	
Model No.:	_____
Serial No.:	_____
Inst date.:	_____
Installer.:	_____





**Melbourne**  
 39-45 Cyber Loop  
 Dandenong VIC 3175  
 P: 03 8796 8600

**Townsville**  
 17 Auscan Crescent  
 Garbutt QLD 4814  
 P: 07 4796 0100

**Sydney Seven Hills**  
 2/2 Welder Road  
 Seven Hills NSW 2147  
 P: 02 9853 2100

**Sydney Moorebank**  
 6/30 Heathcote Road  
 Moorebank NSW 2170  
 P: 02 8778 9500

**Adelaide**  
 13 William Street  
 Mile End South SA 5031  
 P: 08 8152 7600

**Brisbane**  
 1/27 Millenium Place  
 Tingalpa QLD 4173  
 P: 07 3308 5400

**Perth**  
 97 Sheffield Road  
 Welshpool WA 6106  
 P: 08 9350 2600

**Gold Coast**  
 1/28 Export Drive  
 Molendinar QLD 4214  
 P: 07 5552 2600

sales@astralpool.com.au  
[www.astralpool.com.au](http://www.astralpool.com.au)

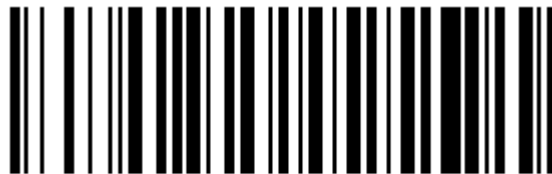

**INST300**